

## Installation Guide – TopJuicer with Deluxe iPad Holder



TopBrewer   
Coffee Reimagined

**Version:** - 0.03

**Date:** - 15/04/2020

**Author(s):** - J. Welch

**Specification:** - U.K. & ROI

## Contents

2. Overview
3. Ventilation 
4. Services – Electrical, water & waste requirements
5. Cupboard dimensions
6. Brita filter dimensions
7. Worktop cut out distance dimensions – Swan neck (faucet) & drip tray
8. Worktop cut out dimensions – Deluxe iPad
9. Flush mounted drip tray (**Recommended**) – For use with hard surfaces i.e. Marble, Granite & Corian worktops
10. Top mounted drip tray – For use with Wood, Chipboard & MDF worktops

## OVERVIEW

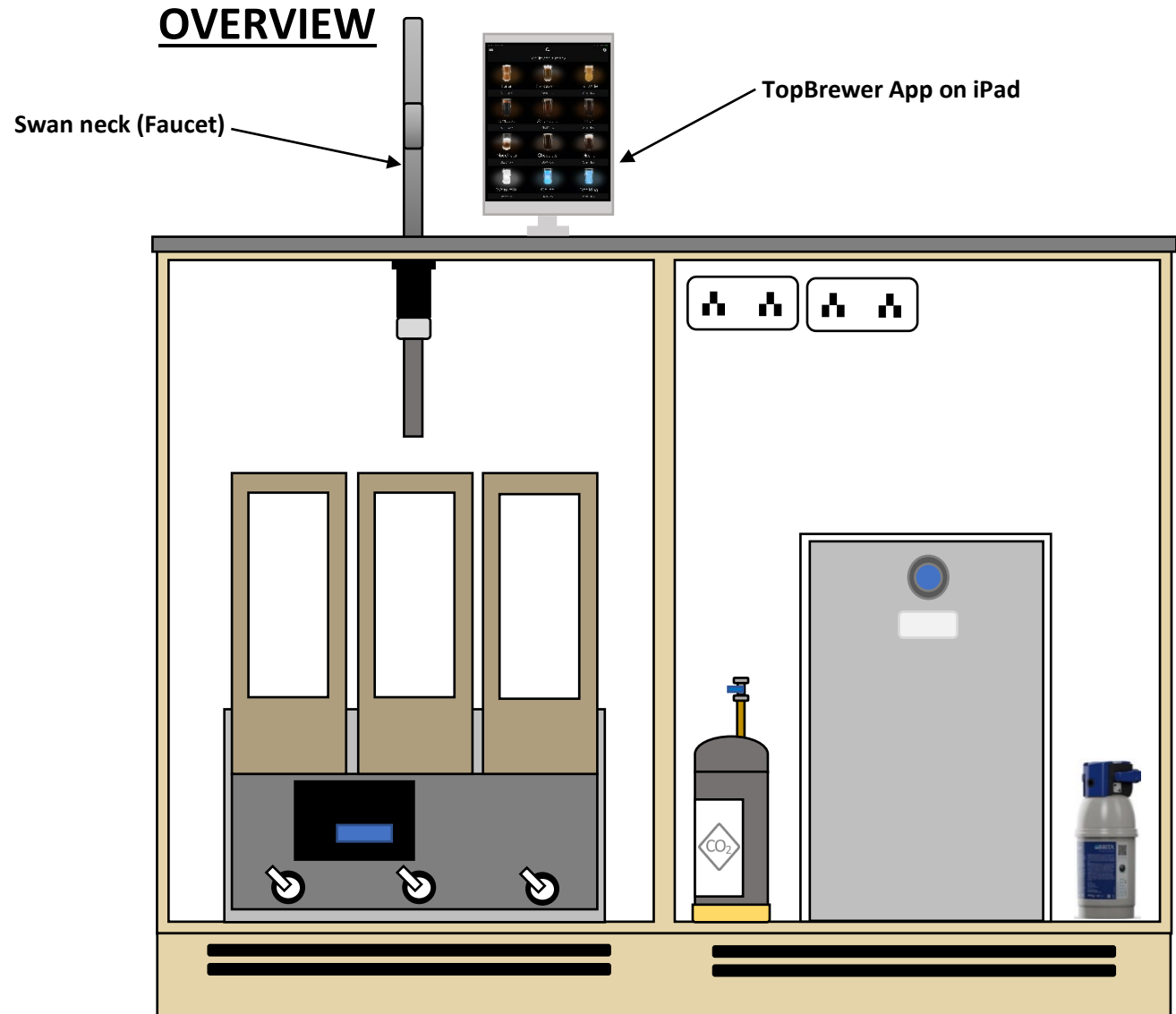

This illustration is to give a visual perspective of how the completed installation will look inside of the cupboards. Below is a list of **MANDATORY** pre-installation requirements before we can proceed with the installation.

1. There **MUST** be a second cupboard for the chiller, filters, water & power (as illustrated).
2. All services **MUST** be easily accessible for quick isolation in case of an emergency.
3. All sockets **MUST** be mounted as close to the iPad as possible to the top corner of the back wall in the adjacent cupboard (as illustrated).
4. Correct cupboard dimensions (pg. 5).
5. Ventilation holes in kick plate and doors (pg. 3).
6. Worktop cut outs for swan neck, iPad holder and drip tray completed with the correct dimensions (pg. 7/8/9) & **MUST** be cut above the TopBrewer cupboard (as illustrated).
7. Chlorination of mains water circuit completed.

## Ventilation

 **Ventilation is a mandatory requirement for the TopBrewer** 

**Failing to install the advised ventilation will prevent us from commissioning the equipment on installation & will also invalidate the warranty.**

- The equipment generates heat which needs to dissipate from the cupboard units. To enable good air flow and circulation ventilation cut outs are required in the kick plates and on top of the cupboard doors as illustrated below.
- For a smarter finish we recommend that the ventilation holes are routed (examples below).
- Standard routed ventilation dimensions (per hole) - **Length** 300 – 400mm **Height** 20mm

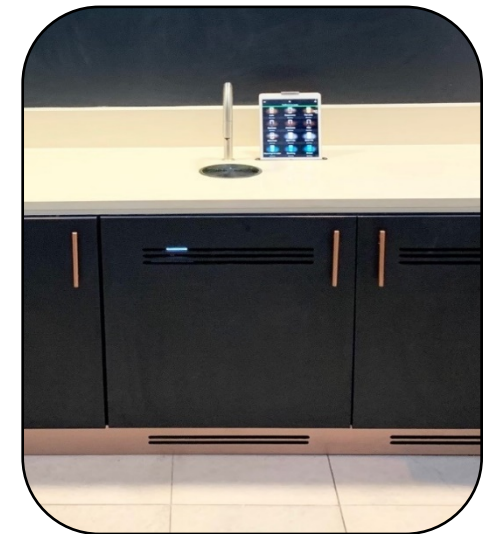
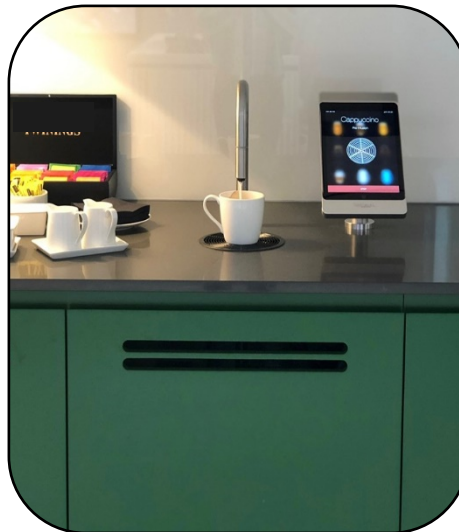

**Please contact us if you have any other alternative ventilation design ideas.**

## Services

### Electrics

2 x 13amp double socket for iPad, fridge & chiller

### Waste

1 x Vertical  $\varnothing$  40mm waste stack with standard u-bend or Hepvo valve trap

### Water

1 x Washing machine valve 15mm x  $\frac{3}{4}$ "

**Mains Pressure: - Min – 2bar Max – 6bar**

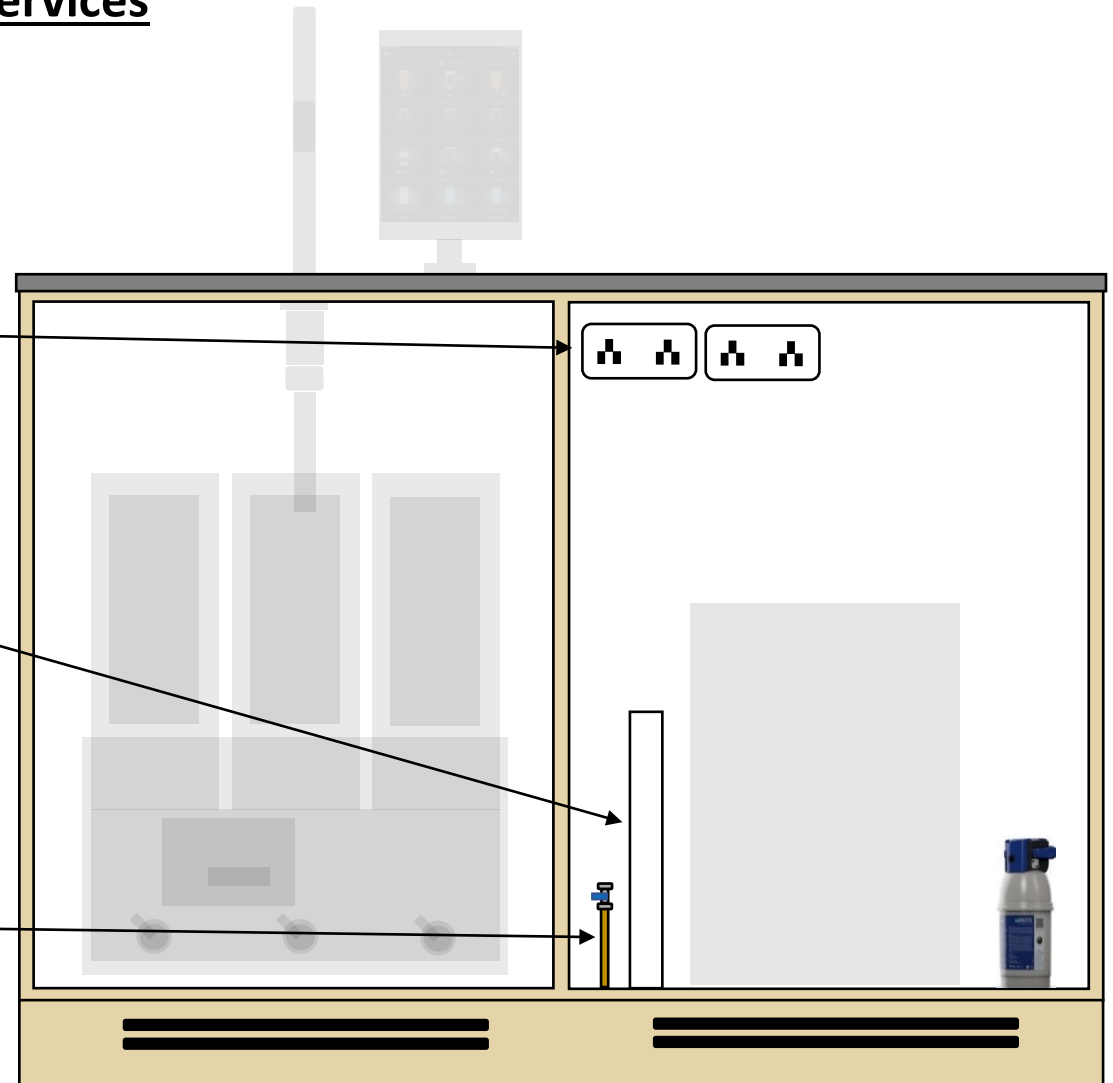

## Cupboard Dimensions

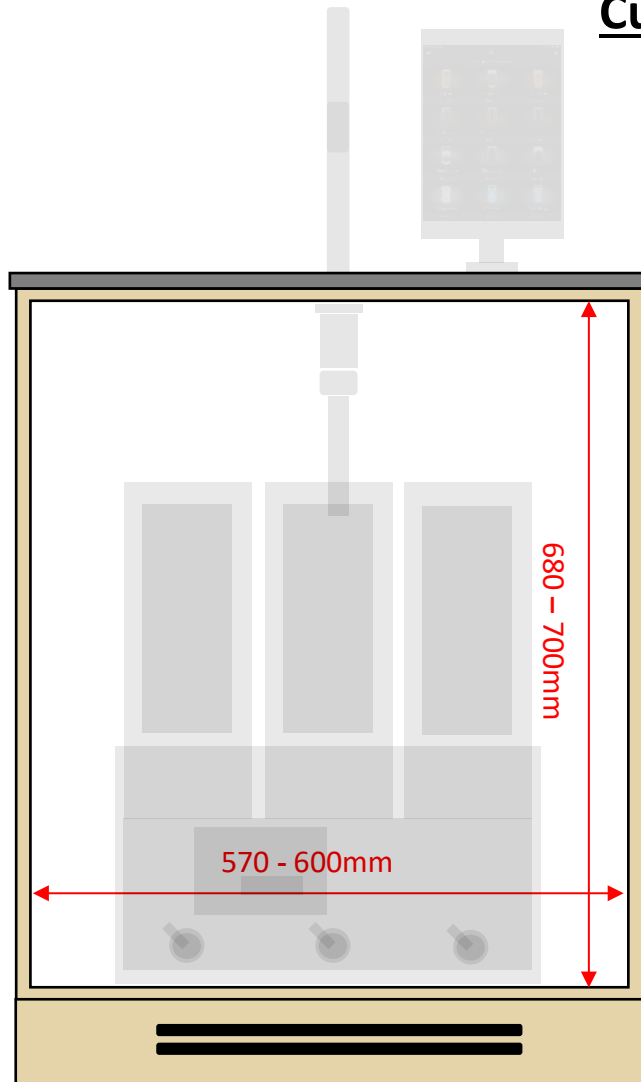

**Width & Height**

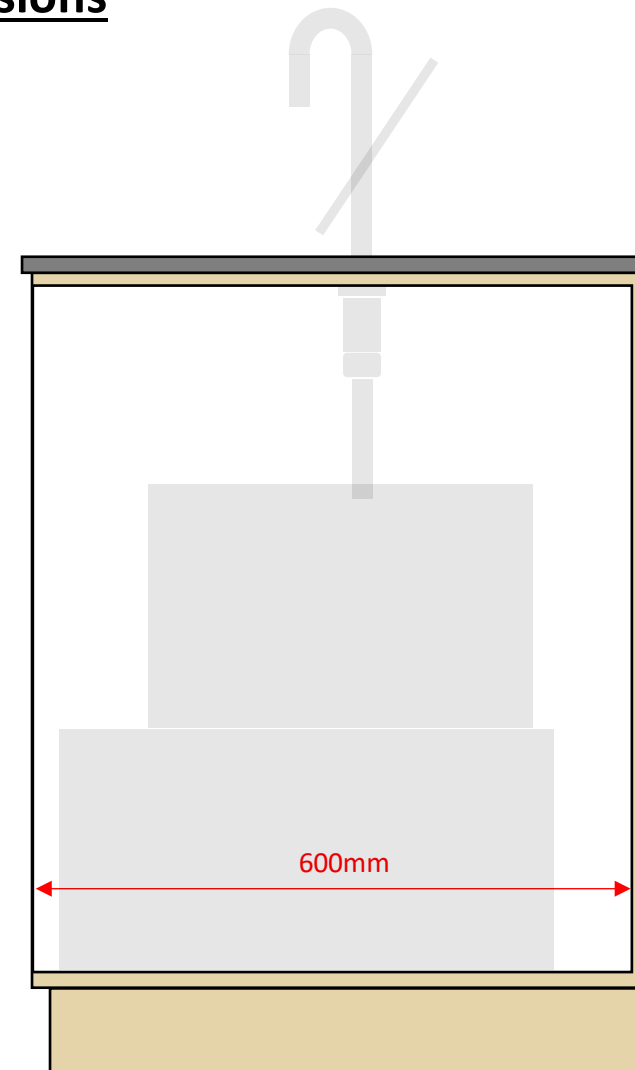

**Depth**

## Brita Filter Dimensions

### Purity C 1000AC



## Work Top Cut Out Distance Dimensions – Swan neck (faucet) & drip tray

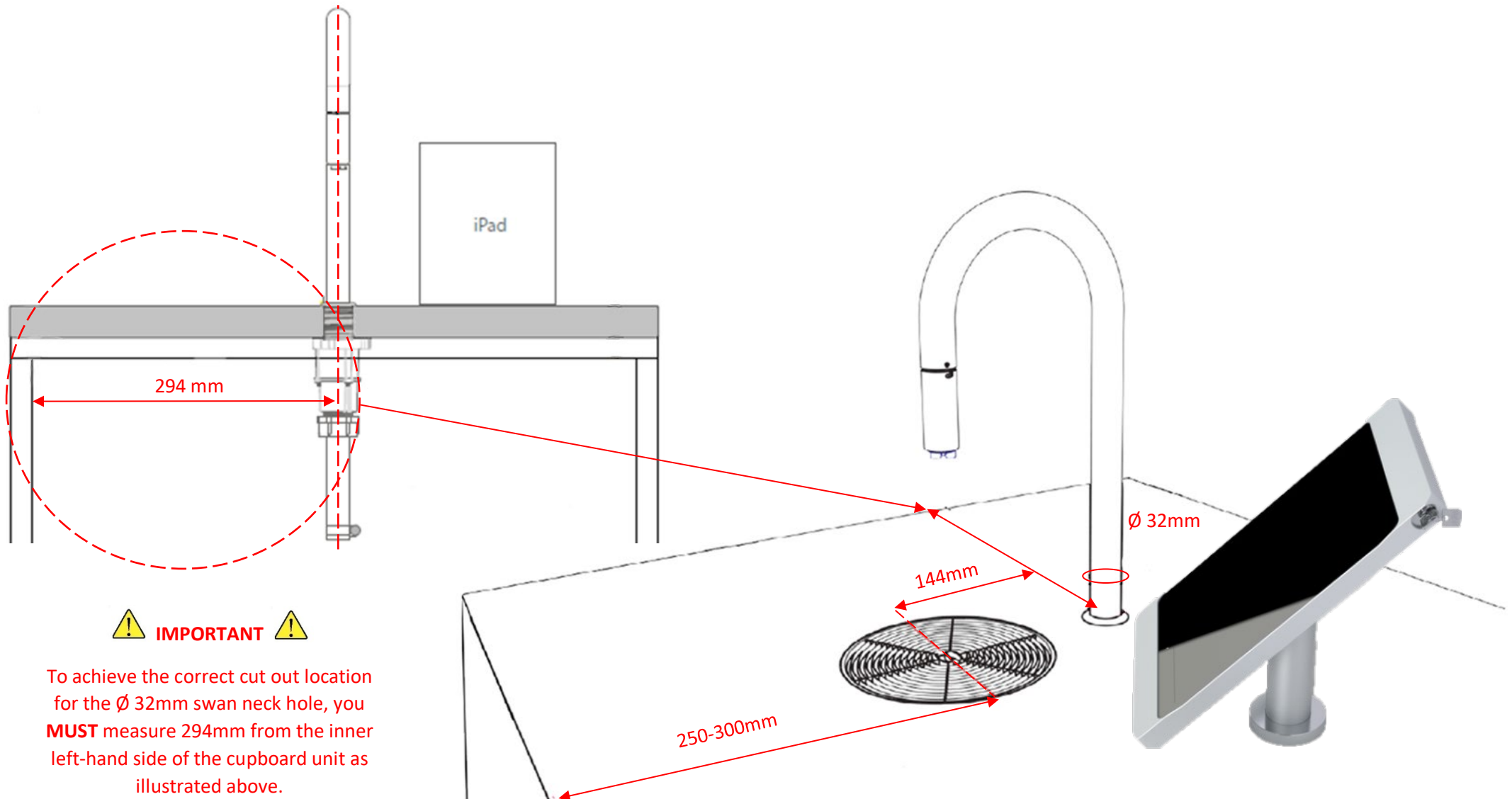

⚠ **IMPORTANT** ⚠

To achieve the correct cut out location for the  $\text{Ø } 32\text{mm}$  swan neck hole, you **MUST** measure 294mm from the inner left-hand side of the cupboard unit as illustrated above.



## Work top Cut Out Dimensions – Deluxe iPad holder

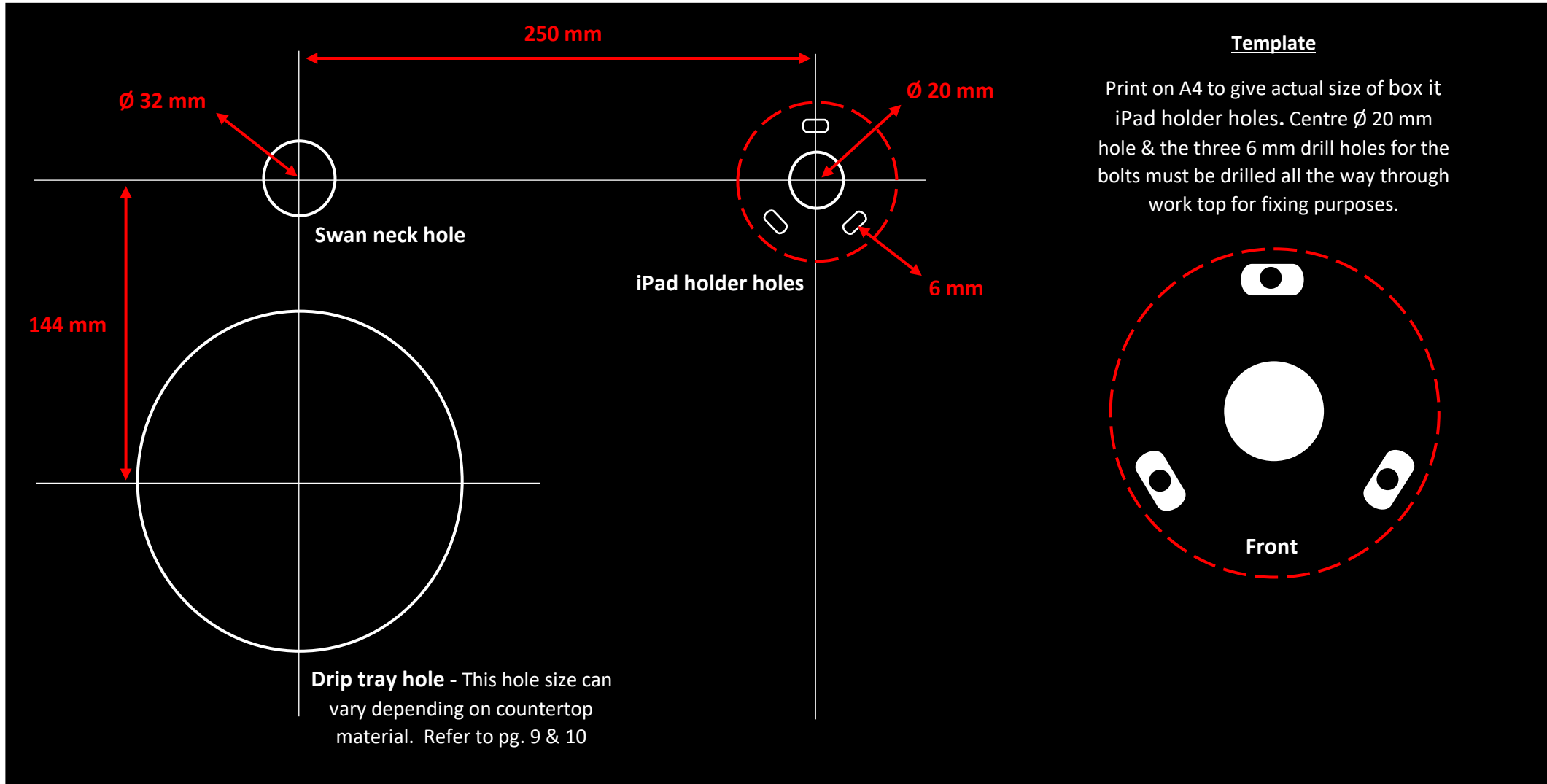

## Flush mounted drip tray (Recommended)

This drip tray is to be used for hard surface worktops such as Marble, Granite & Corian. **NOT** to be used with wooden based materials such as chipboard, MDF etc. Please contact us for advice if required.

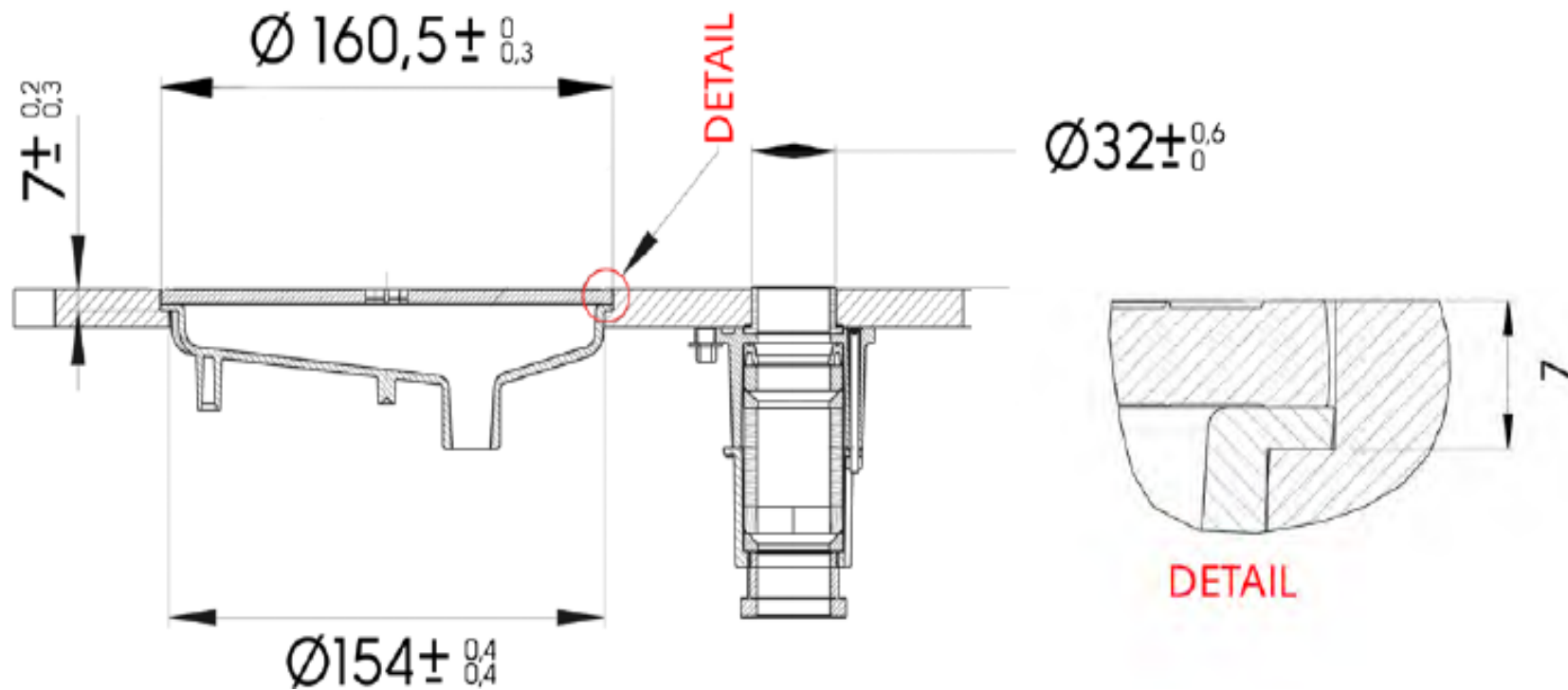

## Top mounted drip tray

This drip tray is to be used for all types of wooden surface worktops i.e. Chipboard, MDF etc. Please contact us for advice if required.

